

500 Series Mini Duty

85  lbs



Excellent for:

- Office Furniture
- Institutional Equipment & Environments
- Food Service Carts and Fixtures
- Store Fixtures & Displays
- Audio & Visual Equipment

Options:

(Swivel only)

- "DLB" - Total Lock-Brake



Finish:

- Bright Zinc



PU
-40° to 194°F
95A +/-3
Polyurethane



ELN
-31° to 248°F
95A +/-3
Nylon

Fitting Codes & Dimensions:

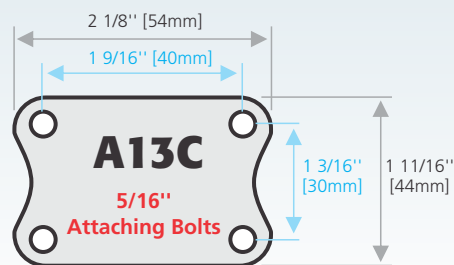

Plate thickness: 5/64" [2mm]

Size	Swivel	Rigid	Wheel Material	Wheel Colour	Wheel Diameter	Tread Width	Capacity	Overall Height	Sw Lead
2"	S0502-A13C-PU-PB	R0502-A13C-PU-PB	PU	Grey	50mm	20mm	85 lbs	2 3/4"	3/4"
2"	S0502-A13C-ELN-PB	R0502-A13C-ELN-PB	ELN	White	50mm	20mm	85 lbs	2 3/4"	3/4"

1200 Series Light Duty

140 lbs



Excellent for:

- Hospitals
- Diagnostic Equipment
- Store Fixtures & Displays
- Audio & Visual Equipment
- Tool Boxes

Options:

(Swivel only)

- "DLB" - Total Lock-Brake
- "HO" - Bolt Hole (For Threaded Stems)



Finish:

- Bright Zinc



PU
-40° to 194°F
95A +/-3
Polyurethane



NY
-30° to 185°F
95A +/-3
Nylon

Fitting Codes & Dimensions:

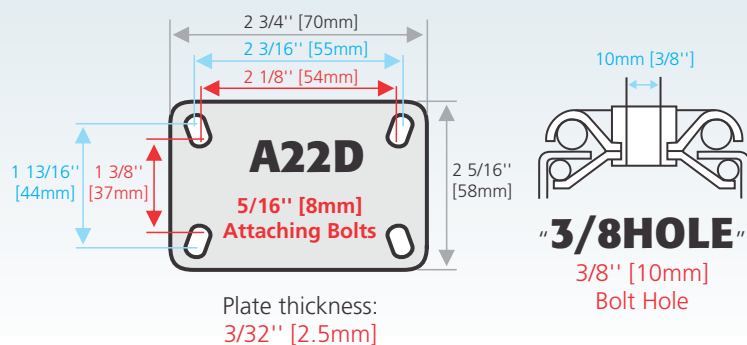

SPECIAL THREADED STEMS

***	DIAMETER	LENGTH
3/8-**X length HO	3/8"	ANY



EXPANDABLE ROUND STEMS

***	DIAMETER	LENGTH	TYPE
3/4RDEXP	3/4"	3 1/8"	Rubber
7/8RDEXP	7/8"	3 1/8"	Rubber



EXPANDABLE SQUARE STEMS

***	DIAMETER	LENGTH	TYPE
3/4SQEXP	3/4"	3 1/8"	Rubber
7/8SQEXP	7/8"	3 1/8"	Rubber

1200 Series Light Duty

140

Size	Swivel	Rigid	Wheel Material	Wheel Colour	Wheel Diameter	Tread Width	Capacity	Overall Height	Sw Lead
2 1/2"	S1225-***-NY	R1225-A22D-NY	NY	Black	65mm	1"	100 lbs	3 5/8"	31mm
2 1/2"	S1225-***-PU	R1225-A22D-PU	PU	Grey	61mm	1"	125 lbs	3 1/2"	29mm
3"	S1203-***-NY	R1203-A22D-NY	NY	Black	75mm	1"	110 lbs	4 3/32"	31mm
3"	S1203-***-PU	R1203-A22D-PU	PU	Grey	75mm	1"	140 lbs	4 3/32"	31mm

*** - Include fitting code into Swivel Part Number (Plate, Bolt Hole or Stem code)

2200 Series Medium Duty 240 lbs



EZC
-40° to 180°F
65A +/-5
Thermoplastic
Elastomer

MPUG
-30° to 180°F
95A +/-5
Polyurethane



IR
-40° to 185°F
75A +/-3
Institutional
Rubber

Excellent for:

- Hospitals
- Schools
- Libraries
- Audio & Visual Equipment
- Food processing Machinery
- Food Equipment
- Metal Fabricators

Options:

(Swivel only)

- "DLB" - Total Lock-Brake 
- "SWLB" - 2 Position Directional Locks 
- "HO" - Bolt Hole (For Threaded Stems) 
- "EXP" - Expanding Stems

Finish:

- Bright Zinc

Fitting Codes & Dimensions:

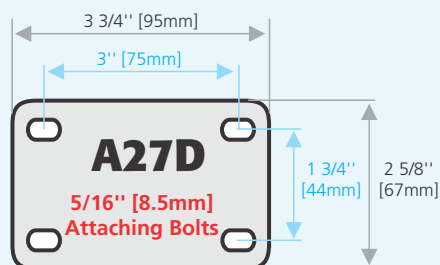

Plate thickness: 3/32" [3mm]

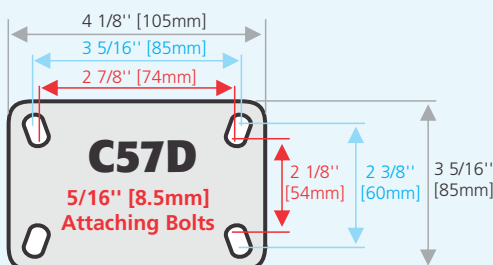
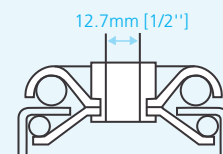

Plate thickness: 3/32" [3mm]
(Swivel only)



"1/2HOLE"
1/2" [12.7mm] Bolt Hole

Optional Bolt Holes:
"3/8HOLE" - 3/8" [10mm]

2200 Series Medium Duty 240 lbs

Size	Swivel	Rigid	Wheel Material	Wheel Colour	Wheel Diameter	Tread Width	Capacity	Overall Height	Sw Lead
3"	S2203-***-IR-PB-TG	R2203-A27D-IR-PB-TG	IR	Grey	75mm	1 1/8"	195 lbs	4 3/8"	32mm
3"	S2203-***-EZC-PB	R2203-A27D-EZC-PB	EZC	Grey	75mm	1 1/4"	240 lbs	4 3/8"	32mm
3"	S2203-***-MPUG-PB	R2203-A27D-MPUG-PB	MPUG	Grey	75mm	1 1/4"	240 lbs	4 3/8"	32mm
4"	S2204-***-IR-PB-TG	R2204-A27D-IR-PB-TG	IR	Grey	100mm	1 3/16"	220 lbs	5 5/16"	34mm
4"	S2204-***-EZC-PB	R2204-A27D-EZC-PB	EZC	Grey	100mm	1 1/4"	240 lbs	5 5/16"	34mm
4"	S2204-***-MPUG-PB	R2204-A27D-MPUG-PB	MPUG	Grey	100mm	1 1/4"	240 lbs	5 5/16"	34mm
5"	S2205-***-IR-PB-TG	R2205-A27D-IR-PB-TG	IR	Grey	125mm	1 3/16"	235 lbs	6 1/4"	35mm
5"	S2205-***-EZC-PB	R2205-A27D-EZC-PB	EZC	Grey	125mm	1 1/4"	240 lbs	6 1/4"	35mm
5"	S2205-***-MPUG-PB	R2205-A27D-MPUG-PB	MPUG	Grey	125mm	1 1/4"	240 lbs	6 1/4"	35mm

*** - Include fitting code into Swivel Part Number (Plate, Bolt Hole or Stem code)



EXPANDABLE ROUND STEMS

***	DIAMETER	LENGTH	TYPE
3/4RDEXP	3/4"	3 1/8"	Rubber
7/8RDEXP	7/8"	3 1/8"	Rubber
1RDEXP	1"	4 1/8"	Rubber
1 1/8RDEXP	1 1/8"	4 1/8"	Rubber
1 3/8RDEXP	1 3/8"	4 1/8"	Rubber
1 1/2RDEXP	1 1/2"	4 1/8"	Rubber



EXPANDABLE SQUARE STEMS

***	DIAMETER	LENGTH	TYPE
3/4SQEXP	3/4"	3 1/8"	Rubber
7/8SQEXP	7/8"	3 1/8"	Rubber
1SQEXP	1"	4 1/8"	Rubber
1 1/8SQEXP	1 1/8"	4 1/8"	Rubber
1 3/8SQEXP	1 3/8"	4 1/8"	Rubber
1 1/2SQEXP	1 1/2"	4 1/8"	Rubber



SPECIAL THREADED STEMS

***	DIAMETER	LENGTH
3/8-**X length HO	3/8"	ANY
1/2-**X length HO	1/2"	ANY

2700 Series Stainless Steel **250** lbs





Excellent for:

- Hospitals
- Bacteria Free Environments
- Food Service Equipment
- Food processing Machinery
- Pharmaceutical Equipment
- Cart Wash Down Applications

Options:

(Swivel only)

- "DLB" - Total Lock-Brake 
- "HO" - Bolt Hole (For Threaded Stems) 
- "EXP" - Expanding Adapters (consult CWBC)



IP
-40° to 190°F
55A +/-3
Institutional Polyurethane



IP-PB-TG
-40° to 190°F
55A +/-3
Institutional Polyurethane
w/Precision Bearing and
Thread Guard



IR
-40° to 185°F
75A +/-3
Institutional TPE



ELN
-31° to 248°F
75D +/-3
Nylon

Finish:

- Stainless Steel

Fitting Codes & Dimensions:

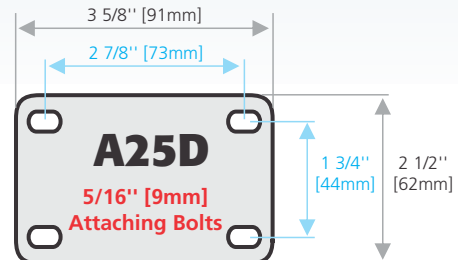
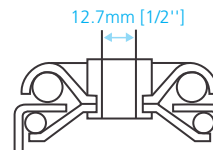











Plate thickness: 5/64" [3mm]



"1/2HOLE"

1/2" [12.7mm] Bolt Hole

2700 Series Stainless Steel 250

Size	Swivel	Rigid	Wheel Material	Wheel Colour	Wheel Diameter	Tread Width	Capacity	Overall Height	Sw Lead
									
3"	S2703-***-IP	R2703-A25D-IP	PU	Grey	75mm	28mm	175 lbs	4 5/32"	32mm
3"	S2703-***-IP-PB-TG	R2703-A25D-IP-PB-TG	PU	Grey	75mm	28mm	175 lbs	4 5/32"	32mm
3"	S2703-***-ELN	R2703-A25D-ELN	Nylon	White	75mm	28mm	195 lbs	4 5/32"	32mm
4"	S2704-***-IP	R2704-A25D-IP	PU	Grey	100mm	30mm	220 lbs	5 3/16"	34mm
4"	S2704-***-IP-PB-TG	R2704-A25D-IP-PB-TG	PU	Grey	100mm	30mm	220 lbs	5 3/16"	34mm
4"	S2704-***-ELN	R2704-A25D-ELN	Nylon	White	100mm	30mm	250 lbs	5 3/16"	34mm
4"	S2704-***-IR-PB-TG	R2704-A25D-IR-PB-TG	TPE	Grey	100mm	31mm	165 lbs	5 3/16"	34mm
5"	S2705-***-IP	R2705-A25D-IP	PU	Grey	125mm	30mm	250 lbs	6 1/4"	36mm
5"	S2705-***-IP-PB-TG	R2705-A25D-IP-PB-TG	PU	Grey	125mm	30mm	250 lbs	6 1/4"	36mm
5"	S2705-***-ELN	R2705-A25D-ELN	Nylon	White	125mm	30mm	250 lbs	6 1/4"	36mm
5"	S2705-***-IR-PB-TG	R2705-A25D-IR-PB-TG	TPE	Grey	125mm	31mm	175 lbs	6 1/4"	36mm

*** - Include fitting code into Swivel Part Number (Plate, Bolt Hole or Stem code)



EXPANDABLE ROUND STEMS

***	DIAMETER	LENGTH	TYPE
3/4RDEXP	3/4"	3 1/8"	Rubber
7/8RDEXP	7/8"	3 1/8"	Rubber
1RDEXP	1"	4 1/8"	Rubber
1 1/8RDEXP	1 1/8"	4 1/8"	Rubber
1 3/8RDEXP	1 3/8"	4 1/8"	Rubber
1 1/2RDEXP	1 1/2"	4 1/8"	Rubber



EXPANDABLE SQUARE STEMS

***	DIAMETER	LENGTH	TYPE
3/4SQEXP	3/4"	3 1/8"	Rubber
7/8SQEXP	7/8"	3 1/8"	Rubber
1SQEXP	1"	4 1/8"	Rubber
1 1/8SQEXP	1 1/8"	4 1/8"	Rubber
1 3/8SQEXP	1 3/8"	4 1/8"	Rubber
1 1/2SQEXP	1 1/2"	4 1/8"	Rubber



SPECIAL THREADED STEMS

***	DIAMETER	LENGTH
3/8-**X length HO	3/8"	ANY
1/2-**X length HO	1/2"	ANY

5600 Series Medium Duty 550 lbs



"Euro-Tech Urethane"™
ETU
-40° to 194°F
95A +/-3
Polyurethane

"Euro-Lite Nylon"™
ELN
-35° to 248°F
75D +/-3
Nylon

Excellent for:

- Store Fixtures
- Platform Trucks
- Food Service Equipment
- Hotel Equipment
- Small Waste Bins
- Stock Trucks
- Factory use
- Textile Plants

Options:

(Swivel only)

- "DLB" - Total Lock-Brake
- "C" - Raceway Seal (Standard Feature)



Finish:

- Zinc Dichromate

Fitting Dimensions:

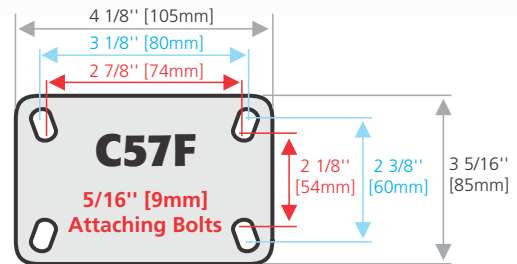

Plate thickness: 5/32" [4mm]

5600 Series Medium Duty 550 lbs

Size	Swivel	Rigid	Wheel Material	Wheel Colour	Wheel Diameter	Tread Width	Capacity lbs	Overall Height	Sw Lead
4"	S5645C-C57F-ELN	R5645-C57F-ELN	ELN	White	100mm	1 1/2"	400 lbs	5 7/16"	35mm
4"	S5645C-C57F-ETU-BB	R5645-C57F-ETU-BB	ETU	Orange	100mm	1 5/8"	350 lbs	5 7/16"	35mm
5"	S5655C-C57F-ELN	R5655-C57F-ELN	ELN	White	125mm	1 1/2"	450 lbs	6 1/2"	40mm
5"	S5655C-C57F-ETU-BB	R5655-C57F-ETU-BB	ETU	Orange	125mm	1 5/8"	395 lbs	6 1/2"	40mm
6"	S5665C-C57F-ELN	R5665-C57F-ELN	ELN	White	150mm	1 1/2"	500 lbs	7 1/2"	38mm
6"	S5665C-C57F-ETU-BB	R5665-C57F-ETU-BB	ETU	Orange	150mm	1 5/8"	425 lbs	7 1/2"	38mm

5500 Series Medium Duty 550 lbs



GFN
-30° to 212°F
85D +/-5
Glass Filled Nylon

Excellent for:

- Pianos & Heavy Equipment
- Business Machine
- Low Profile Heavy Applications
- Paper Mills
- Storage Facilities
- Textile Plants

Finish:

- Bright Zinc

Fitting Dimensions:

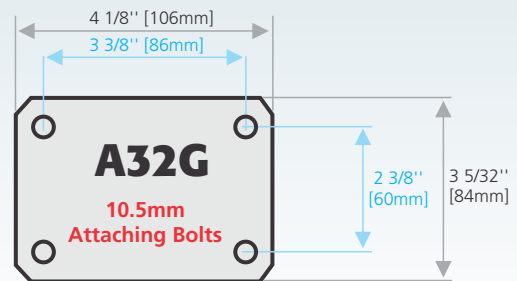

Plate thickness: 5/32" [5mm]

Size	Swivel	Rigid	Wheel Material	Wheel Colour	Wheel Diameter	Tread Width	Capacity	Overall Height	Sw Lead
3"	S5503-A32G-GFN-BB	R5503-A32G-GFN-BB	GFN	Black	75mm	2" [50mm]	500 lbs	4 1/8" [105mm]	24mm
4"	S5504-A32G-GFN-BB	R5503-A32G-GFN-BB	GFN	Black	100mm	2" [50mm]	550 lbs	5 1/8" [130mm]	24mm

7800 Series Heavy Duty 2000 lbs



Excellent for:

- Abusive Conditions
- Tow Lines
- Industrial Platform Trucks
- Heavy Waste Bin Applications
- Most Hardworking Industrial Functions
- Economic Choice for heavy loads

Options:

(Swivel only)

- "PWB" - Pedal Wheel-Brake



Finish:

- Bright Zinc



"HD Euro-Lite Nylon"
ELNX
-30° to 248°F
75D +/-3
Nylon



"Moldon Urethane"
UR
-40° to 194°F
95A +/-3
Urethane on Iron



Solid Crowned Iron
SSC
-45° to 180°F (Standard)
Consult CWBC for
temperatures to 800F
95-98 Shore D
Crowned Cast Iron



"Crowned TPU"
TPUC
-40° to 194°F
95A +/-3
TPU on Nylon Core

Fitting Dimensions:

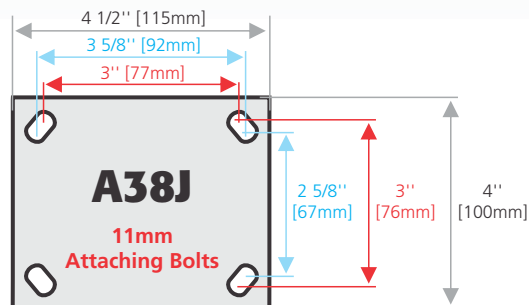

Plate thickness: 3/8" [9.5mm]

7800 Series Heavy Duty 2000 lbs

Size	Swivel	Rigid	Wheel Material	Wheel Colour	Wheel Diameter	Tread Width	Capacity	Overall Height	Sw Lead
6"	S7806-A38J-ELNX-BB	R7806-A38J-ELNX-BB	ELNX	White	150mm	2" [50mm]	1700 lbs	7 5/8" [193mm]	49mm
6"	S7806-A38J-UR-BB	R7806-A38J-UR-BB	Moldon Urethane	Red on Black	150mm	2" [50mm]	1500 lbs	7 5/8" [193mm]	49mm
6"	S7806-A38J-SSC-BB	R7806-A38J-SSC-BB	Cast Iron	Grey	150mm	1 7/8" [45mm]	1900 lbs	7 5/8" [193mm]	49mm
6"	S7806-A38J-TPUC-BB	R7806-A38J-TPUC-BB	Crowned TPU	Blue on Grey	150mm	2" [50mm]	900 lbs	7 5/8" [193mm]	49mm
8"	S7808-A38J-ELNX-BB	R7808-A38J-ELNX-BB	ELNX	White	200mm	2" [50mm]	1800 lbs	9 5/8" [244mm]	47mm
8"	S7808-A38J-UR-BB	R7808-A38J-UR-BB	Moldon Urethane	Red on Black	200mm	2" [50mm]	1600 lbs	9 5/8" [244mm]	47mm
8"	S7808-A38J-SSC-BB	R7808-A38J-SSC-BB	Cast Iron	Grey	200mm	1 7/8" [45mm]	2000 lbs	9 5/8" [244mm]	47mm
8"	S7808-A38J-TPUC-BB	R7808-A38J-TPUC-BB	Crowned TPU	Blue on Grey	200mm	2" [50mm]	950 lbs	9 5/8" [244mm]	47mm